



Schwiebacher Abbruch Technik

Werkstatt • Lager • Service seit 1977

D-82229 Seefeld (bei München)

Graf-Toerring-Seefeld-Strasse 9b / 17

Tel. 08152 / 998 969-0 Fax.- 9

T.50 GRABENRÄUM-LÖFFEL (Holland-Profil) optimal* für Bagger von 9,6 bis 12,5 to

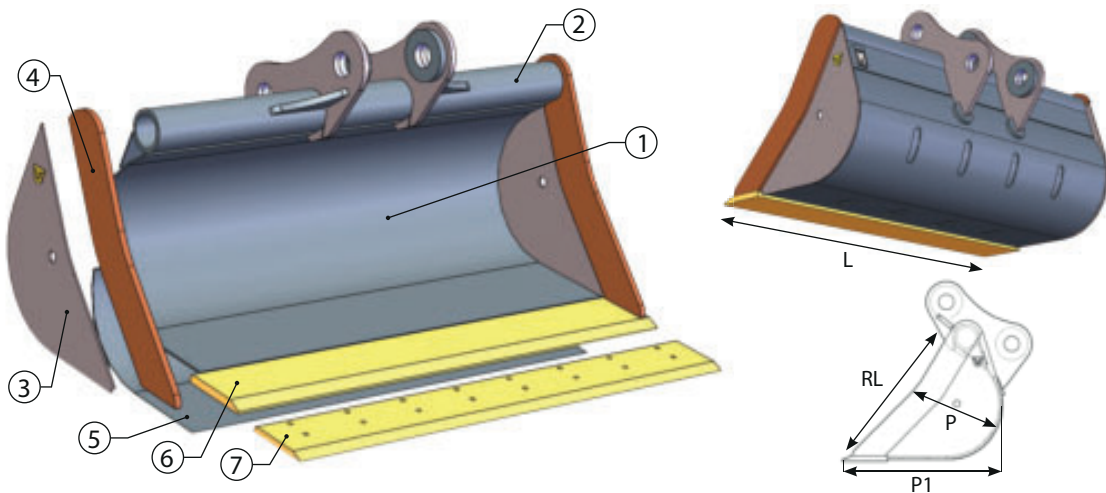

Classe Class	Codice Code	L mm.	Cap. SAE Lt.	Peso Kg. Weight	RL mm.	P mm.	P1 mm.	Listino € Price List	Sottolama € Bolt on blade
T.50 9,6 - 12,5 ton	WPE048-140	1400	348	240	649	358	651	1.732,00	256,00
	WPE048-150	1500	375	250				1.790,00	276,00
	WPE048-160	1600	403	265				1.884,00	294,00
	WPE048-180	1800	458	285				2.016,00	328,00
	WPE048-200	2000	513	320				2.256,00	368,00
		1	2	3	4	5	6	7 Optional	8
Materiale	Material	S355	S355	S355	Hardox 400	S355	HB 400	HB 400	/
Spessore	Thickness	6 mm	114.3 x 12.5 mm	8 mm	15 mm	6 mm	200 x 20 mm	200 x 20 mm	/

T.50 * optimal = für Bagger von 9,6 bis 12,5 t mit Standard-Ausrüstung.

AKERMANN H 3B * ATLAS 1104, 1204 * BENATI 3.12R * BENFRA 3R, 3C * BOBCAT 444 * CASE WX 120, 488 * CATERPILLAR 311 FLRR * COSMOTER BAT10 0 * EUROMACH 9000, 9500 * FIAT HITACHI FH 115W, FH 120W, EX 100, FH 115, FH 125W * FIAT KOBELCO E 115SR, EX 125W * HYUNDAI R 110LC7 * JCB JS 110, JZ 115, 100C, HYDROADIG 110W * KOBELCO SK 100, SK 115SR * KOMATSU PC 110R, PC 110R1, PW 110R, PW 118, PC 118, PC 118MR-8, PW 98MR-8, PW 118MR-8 * LALTESI 40/111 * LIEBHERR A 309, A 310, A 311, A 910CPT LIT * Macmoter M 12M/BW 110 * MECALAC 14 MX, 14 MBX, 12 MTX * NEW HOLLAND MH 2.6, MH 3.6, E 115SR * O&K MH 2.10/MH 3.5; PMI 450/810R/913 * TEREX HR 42, TW 110, TC 125 * VENERI VF 10.23D * MF 250 * WACKER NEUSON 11002 RD, 12002 RD, 1454, EW 100 * YANMAR Vio 100, SV 100-2, SV 100-2PB

geeignet = für Bagger von 7,5 bis 16 t je nach Ausrüstung.

Andere Klassen/Größen bedingt geeignet. Bei Bedarf bitte anfragen!

Info: 05/2021



Schwiebacher Abbruch Technik

Werkstatt • Lager • Service ^{seit 1977}

D-82229 Seefeld (bei München)

Graf-Toerring-Seefeld-Strasse 9b / 17

Tel. 08152 / 998 969-0 Fax.- 9

T.55 GRABENRÄUM-LÖFFEL (Holland-Profil) optimal* für Bagger von 12,6 bis 16 to

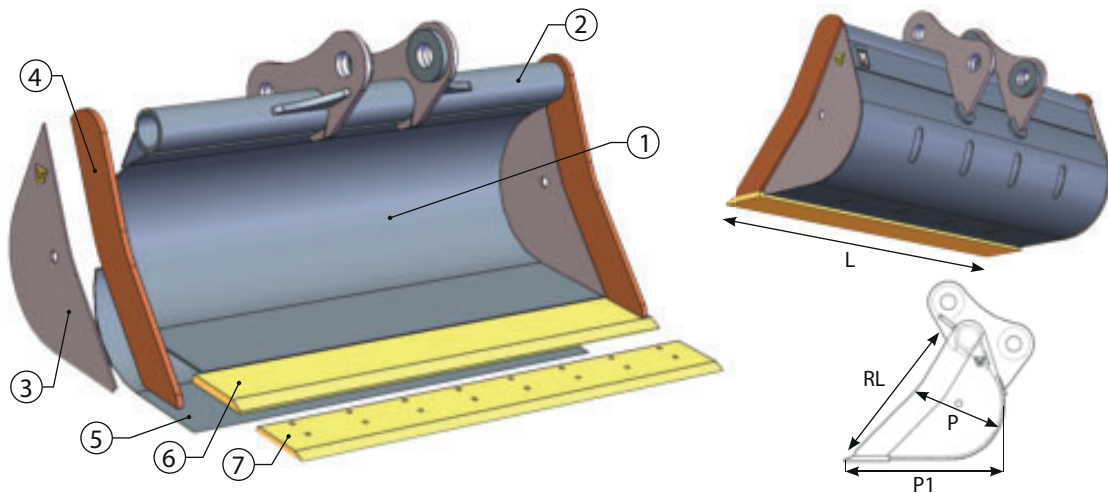

Classe Class	Codice Code	L mm.	Cap. SAE Lt.	Peso Kg. Weight	RL mm.	P mm.	P1 mm.	Listino € Price List	Sottolama € Bolt on blade
T.55 12,6 - 16 ton	WPE055-150	1500	585	412	830	445	830	2.458,00	422,00
	WPE055-160	1600	629	437				2.594,00	448,00
	WPE055-180	1800	717	477				2.818,00	506,00
	WPE055-200	2000	805	517				3.038,00	562,00
	WPE055-220	2200	893	557				3.256,00	618,00
		1	2	3	4	5	6	7 Optional	8
Materiale	Material	S355	S355	S355	Hardox 400	S355	HB 400	HB 400	/
Spessore	Thickness	8 mm	127 x 14.2 mm	8 mm	20 mm	8 mm	250 x 25 mm	250 x 25 mm	/



Schwiebacher Abbruch Technik

Werkstatt • Lager • Service seit 1977

D-82229 Seefeld (bei München)

Graf-Toerring-Seefeld-Strasse 9b / 17

Tel. 08152 / 998 969-0 Fax.- 9

T.55 GRABENRÄUM-LÖFFEL (Holland-Profil) optimal* für Bagger von 12,6 bis 16 to

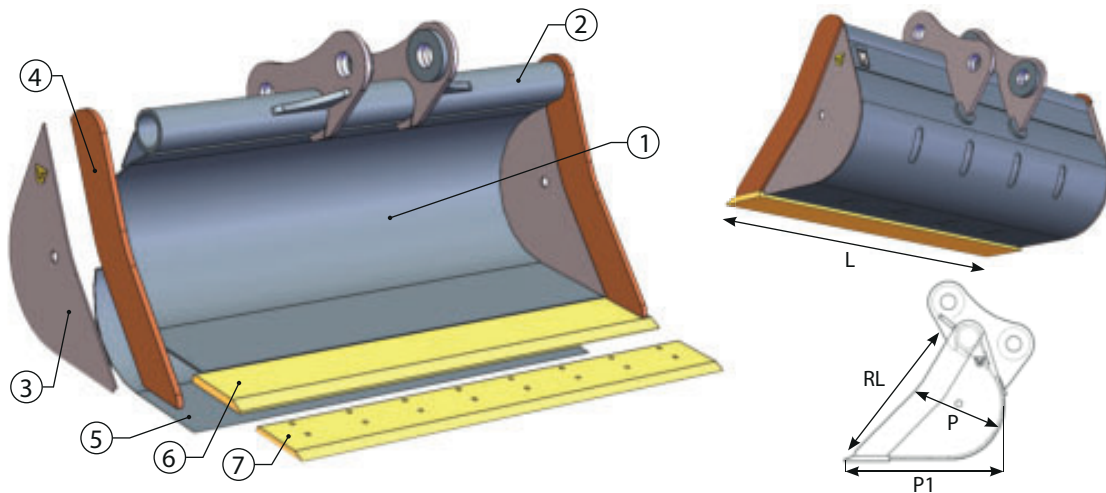
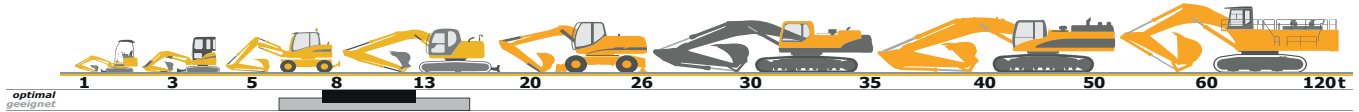

T.55 *optimal = für Bagger von 12,6 bis 16 t mit Standard-Ausrüstung.

AKERMANN H 52 * **ATLAS** 1302, 1304M, 1304LC, 1404M, 1404LC, 140 W, 150 W * **BENATI** 90, 120, 140, 145, 3.15, 3.16, 3.17 * **BENFRA** 4R, 4C, 5, 9.05, 9.06 * **CASE** 588, 9013, CX 130, CS 135SR, WX 125, WX 145, CX 130D, CX 145 DSR, WX 148, WX 150 * **CATERPILLAR** EB 120, 205, 206, M 312, M 313C/D, M 315, 311C/D, 312C/D, 314C/D, 211, 212, 312E, 313F, 313F LGC * **COSMOTER** BAT 12, 14 * **JON DEERE** 120D, 135D, 130G, 135G, 160 GLC, 160D * **DAEWOO DOOSAN** DH 130.2, S 110, S 130W-III, S 130LCV/DX, S 140WV/DX, S 160WV, S 140 LCV, S 150 LCV * **FAI** 1000 C, CH, GTH * **FIAT HITACHI** FH 120, FH 130.3, EX 135 * **FIAT KOBELCO** E 135, E 135SR, E 145W * **FORD** 42 * **Furukawa** W 625E, W 630, W 635, W 725LS, W 730LS * **HALLA** HE130W/H E 130LC * **HIDROMEK** HMK 140W, HMK 140, HMK 140LC, HMK 145 * **HITACHI** ZX 110, ZX 130, ZX 135US, ZX 130W, ZX 140W, ZW 145W, ZX 130-6, ZX 135US-6, ZX 130-5G, ZX 130LCN-6, ZX 140W-3F, ZX 140W-6, ZX 145W-6, ZX 160LC-5G, ZX 160LC-6 * **HYUNDAI** R 120W, R 125, R 130W-3, R 130LC-3, 140W-7/9, R 140LC-7/8/9, HX140L, HX 145LCR, R 145-9 * **JCB** JS 130, JS 130W, JS 140, JZ 140, JS 145W * **HYDROMAC** H 75 * **KOBELCO** SK 120, SK 135 SRLC, 903B, SK 140 SRLC-3, SK 140 SRLC-5, ED 160-3, ED 160-5 * **KOMATSU** PC 120, PC 130, PW 130-7, PC 138US-2, PW 148, PC 150.3, PC 138US-10, PC 138US-11, PW 148-8, PW 148-10, PW 160-8 * **LIEBHERR** R 310B, R 312, A 314, A 316, R 313, A 912 CPT LIT * **LATESI** 50, 221, 222 * **MECALAC** 714 MC, 714 MW, 714 MWE, 714 MCE * **NEW HOLLAND** MH 3.6, E 115 SR, E 145, E 135 SRLC/SRL, MH CITY, MH 4.6 * **SANY** SY 135C, SY 11W, SY 155U * **PMI** 700/8.15/8.17 * **Poclair** TCS 45, 60 * **ROCK** 75 * **SAMSUNG** SE 130LC.2, SE 130W.3 * **TAKEUCHI** TB 1140, TB 2150 * **VOLVO** EC/EW 130, EC 140B/C/E, EW 140B/C/D, EC 150, EW 160B/C, ECR 145C, ECR 145E, EWR 150E * **WACKER NEUSON** ET 145 *

geeignet = für Bagger von 8 bis 18 t je nach Ausrüstung.

Andere Klassen/Größen bedingt geeignet. Bei Bedarf bitte anfragen!



Schwienbacher Abbruch Technik

Werkstatt • Lager • Service ^{seit 1977}

D-82229 Seefeld (bei München)

Graf-Toerring-Seefeld-Strasse 9b / 17

Tel. 08152 / 998 969-0 Fax.- 9

T.60 GRABENRÄUM-LÖFFEL (Holland-Profil) optimal* für Bagger von 16 bis 19 to

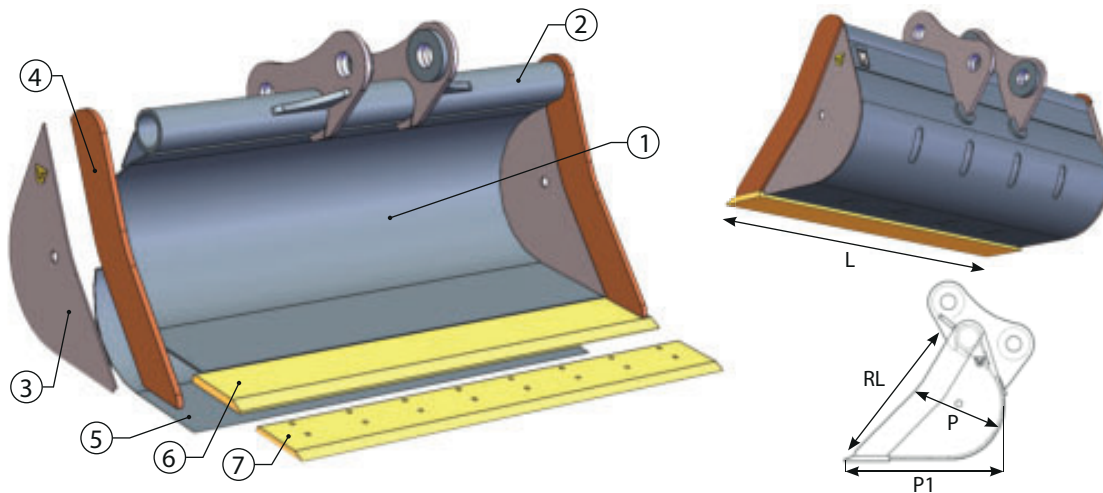
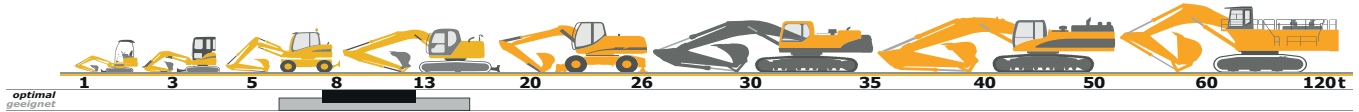

Classe Class	Codice Code	L mm.	Cap. SAE Lt.	Peso Kg. Weight	RL mm.	P mm.	P1 mm.	Listino € Price List	Sottolama € Bolt on blade
T.60 16 - 19 ton	WPE060-150	1500	677	446	900	473	895	2.634,00	422,00
	WPE060-160	1600	730	471				2.770,00	448,00
	WPE060-180	1800	832	511				2.988,00	506,00
	WPE060-200	2000	935	556				3.236,00	562,00
	WPE060-220	2200	1038	601				3.478,00	618,00
		1	2	3	4	5	6	7 Optional	8
Materiale	Material	S355	S355	S355	Hardox 400	S355	HB 400	HB 400	/
Spessore	Thickness	8 mm	127 x 14.2 mm	8 mm	20 mm	8 mm	250 x 25 mm	250 x 25 mm	/



Schwiebacher Abbruch Technik

Werkstatt • Lager • Service seit 1977

D-82229 Seefeld (bei München)

Graf-Toerring-Seefeld-Strasse 9b / 17

Tel. 08152 / 998 969-0 Fax.- 9

T.60 GRABENRÄUM-LÖFFEL (Holland-Profil) optimal* für Bagger von 16 bis 19 t

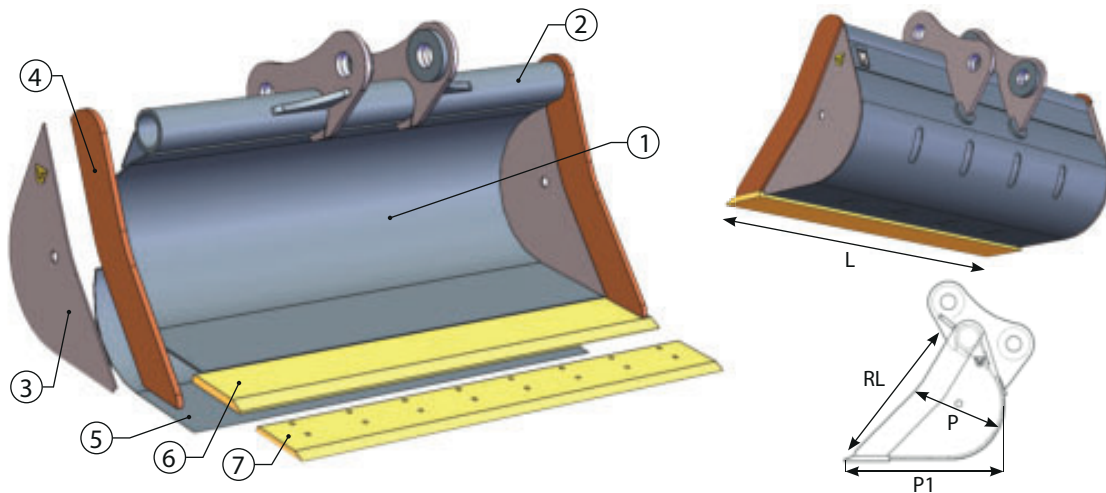

T.60 *optimal = für Bagger von 16 bis 19 t mit Standard-Ausrüstung.

AKERMANN H75, H 7C * **ATLAS** 1604M, 1604LC, 1622, 160 W, 160 LC * **BENATI** 160, 3.18
 * **BENFRA** 6C, 7R, 7.07, 7.08, 9.07, 9.08, 9.20 * **CASE** 688, 688B, 788, CX 160, WX 165, WX
 170, CX 180, CX 160D, WX 168, CX 180D * **COSMOTER** BAT 16 * **CATERPILLAR** 211, 212,
 213B, 214, 214B, 315C/D, 317, 318, M316C/D, M318C/D, 215C/D, M315D, 314E LCR, 315F,
 316E/F * **JON DEERE** 180 GLC, 190 DW, 190 GW * **DAEWOO DOOSAN** DH 170, DH 180, DX
 160, DX 170, DX 180, DX 170III/V, S 175LCV, S 180WV, DX 190W, DX 165W-5, DX 170W-5, DX
 180LC-3, DX 180LC-5, DX 190W-3, DX 190W-5 * **FAI** 1100 * **FIATALLIS** FE 18 * **FIAT**
HITACHI FH 150.3, EX 165, FH 150W.2, FH 150W.3, EX 165W * **FIAT KOBELCO** E 165LC, E
 175W * **FORD** 44, 45 * **FURUKAWA** 635E * **HITACHI** ZX 160LC, ZX 180LC, ZX180W, ZX 170W-
 3F, ZX 170W-6, ZX 180LC-6, ZX 180LC-5G * **HYDROMAC** H 85 * **HYUNDAI** R 160LC-3/7/9, R
 170W-3/9, R 180LC-3/7/9, HW 160, HW 180, HX 160L, HX 180L * **JCB** JJS 150, JS 160LC, JS
 160W, JS 175W, JS 180LC, JZ 190, JS 160 * **KOBELCO** SK 150, SK 160LC, 904, 905B, SK 170LC
 * **KOMATSU** PC 160-7, PW 160-7, PW 170, PC 180-7, PW 180-7, PC 190, PC 170LC-10, PC
 170LC-11, PC 170LC-10 LGP, PW 160-10, PW 180-7, PW 180-10 * **LALTESI** 80, 341, 341HD
 * **LIEBHERR** A 900C, A 900B LIT, A 902 LIT, A 314 LIT, A 316 LIT, R 317, A 918, R 914 CPT LIT,
 A 916 LIT, A 918 CPT LIT, A 918 LIT, A 914 CPT LIT, A 914 LIT * **MF 350D, 350E** * **NEW**
HOLLAND E 175, MH PLUS, MH PLUS C, MH 5.6 * **O&K** RH 5/RH 5PLUS/RH 5 PMS/MH 5/MH
 5PMS/RH 5.5 * **PMI** 900, 8.18 * **POCLAIN** 61, 75, 688 * **ROCK** 100 * **SAMSUNG** SE 170W.3
 * **VOLVO** EC 160B/C, EC 170, EW 170, EC 180B/C, EW 180B/C, EW 160E, EC 160E, EW 180E, EC
 180E *

geeignet = für Bagger von 14 bis 23 t je nach Ausrüstung.
 Andere **Klassen/Größen** bedingt geeignet. Bei Bedarf bitte anfragen!

Info: 05/2021



Schwienbacher Abbruch Technik

Werkstatt • Lager • Service seit 1977

D-82229 Seefeld (bei München)

Graf-Toerring-Seefeld-Strasse 9b / 17

Tel. 08152 / 998 969-0 Fax.- 9

T.65 GRABENRÄUM-LÖFFEL (Holland-Profil) optimal* für Bagger von 19 bis 23 to

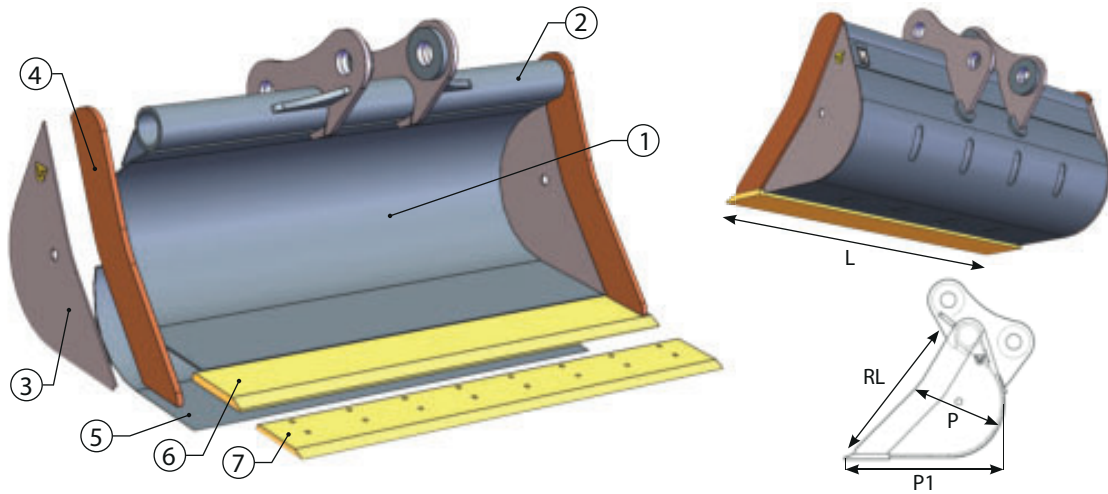
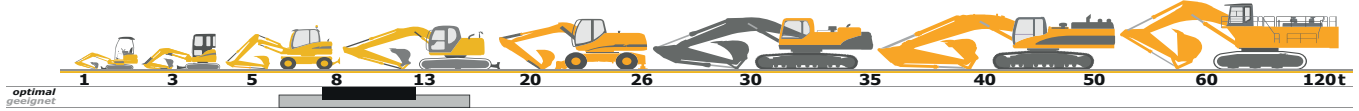

Classe Class	Codice Code	L mm.	Cap. SAE Lt.	Peso Kg. Weight	RL mm.	P mm.	P1 mm.	Listino € Price List	Sottolama € Bolt on blade
T.65 19 - 23 ton	WPE065-160	1600	820	572	956	515	950	3.446,00	448,00
	WPE065-180	1800	937	622				3.776,00	506,00
	WPE065-200	2000	1054	672				4.048,00	562,00
	WPE065-220	2200	1171	722				4.310,00	618,00
	WPE065-240	2400	1288	772				4.576,00	674,00
	WPE065-250	2500	1346	802				4.720,00	704,00
		1	2	3	4	5	6	7 Optional	8
Materiale	Material	S355	S355	S355	Hardox 400	S355	HB 400	HB 400	/
Spessore	Thickness	8 mm	152.4 x 16 mm	8 mm	25 mm	8 mm	270 x 32 mm	250 x 25 mm	/



Schwiebacher Abbruch Technik

Werkstatt • Lager • Service seit 1977

D-82229 Seefeld (bei München)

Graf-Toerring-Seefeld-Strasse 9b / 17

Tel. 08152 / 998 969-0 Fax.- 9

T.65 GRABENRÄUM-LÖFFEL (Holland-Profil) optimal* für Bagger von 19 bis 23 to

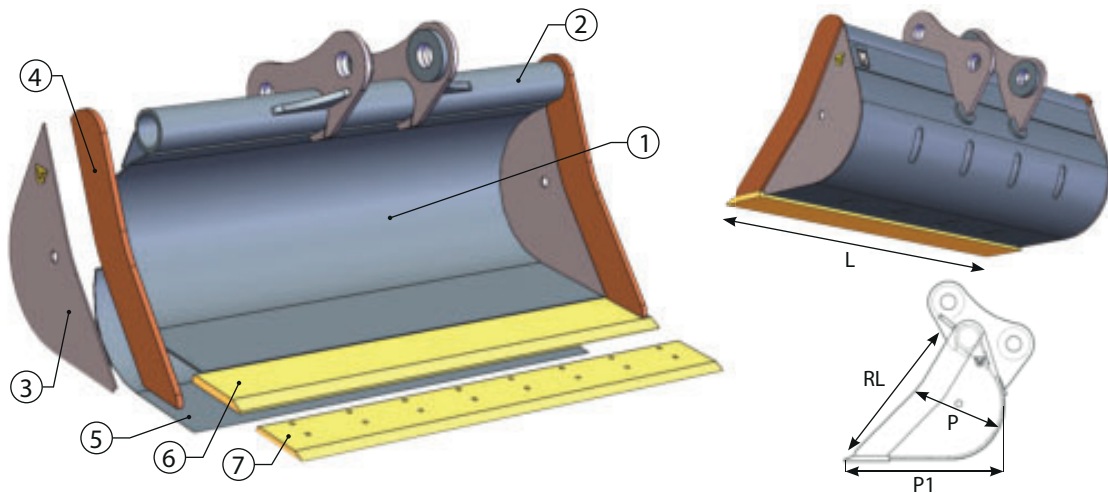

T.65 *optimal = für Bagger von 19 bis 23 t mit Standard-Ausrüstung.

ATLAS 1702D, 1704D, 1704LC, 170 LC, 175 LCSR, 190 W, 190 LC, 215 LCSR

* **BENATI** 190CSB, 3.20, 3.21 * **BENFRA** 8C, 9.09 * **CASE** 888, 988, 9021, WX 185, WX 200, CX 210D, CX 225, CX 235, WX 218, CX 230D, CX 240D * **CATERPILLAR** 219C/D, 318B, 319C/D, M 320, M 322C/D, 320B/D, 321D, 323D, 318E, 318F, 323 ELN, 323 ESA

* **COSMOTER** 8, 9.09 * **JON DEERE** 200D, 220DW, 225D, 210 GLC * **DAEWOO DOOSAN** S 200WIII/V, DX 210WV, DH 220LC, S 220LCVIII/V, S 225LCV, DX 225, DX 235, DX 210W-5, DX 225LC-3, DX 235 LCR-5, DX 235 NLC-5 * **FAI** 1200/1300CH/GTH/1400/1500 * **FIATALLIS** FE 20 * **FIAT HITACHI** FH 200W.3, EX 200, EX 215, EX 235 * **FIAT KOBELCO** E 200SR, E 215E, E 235E, E 235SR * **FORD** 47 * **FURUKAWA** 640E/W 735LS/W 738LS * **HIDROMEK** HHMK 200W, HMK 220, HMK 220LC * **HITACHI** ZX 190LC-6, ZX 190LCN-6, ZX 200LC-3G, ZX 190W-3F, ZX 190W-6, ZX 200LC-5G, ZX 210-6 * **HYDROMAC** H 95/H 105/H 115 * **HYUNDAI** R 200W, R 200LC, R 210LC-3/7/9, HW 210, HX 220L, R 210 NLC-7A * **JCB** JS 200W, JS 200LC, JS 210, JS 220, JS 235, JZ 235, JS 190, JS 220W * **KOBELCO** SK 200, SK 210LC, 907, SK 200SR, SK 180LC-10, SK 210H LC-10, SK 210LC-10, SK 230 SRLC-3 * **KOMATSU** PC 200, PC 228US-8, PW 210, PW 220-7, PC 230N-7/8, PC 210 LC/NLC-8, PC 228 USLC-10 * **LALTESI** 441HD

* **LIEBHERR** A 904C, A 904 LIT, A 912 LIT, A 914B, A 914 LIT, R 900B/C LIT, R 904 LIT, R 906, R 918 LIT, R 920 CPT LIT, R 920 LIT, A 920 LIT, A 924 LIT, R 922 LIT, A922 RAIL LIT, A 924 LIT * **MF** 822, 9.21, 9.22 * **NEW HOLLAND** E 215 E/LC, E 195 EL/LC, E 200 SR/SRLC, E 215C, E 226C, E 245C, MH 6.6, MH 8.6 * **O&K** RH 5/RH 5PLUS/RH 5 PMS/MH 5/MH 5PMS/RH 5.5

* **PMI** 900, 8.18 * **POCLAIN** 81, 888 * **ROCK** 130, 135 * **SANY** SY 135C, SY 11W, SY 155U * **SAMSUNG** SE 210LC.3, SE 210W.2 * **TEREX** TC 210LC, TC 210NLC, TC 225LC, TC 225NLC * **VOLVO** EC 200, EW 200, EC 210B/C, EC 230, EW 230, EC 235C, ECR 235C, EW 210D, EC 220E

geeignet = für Bagger von 17 bis 26 t je nach Ausrüstung.

Andere **Klassen/Größen** bedingt geeignet. Bei Bedarf bitte anfragen!

Info: 05/2021



Schwienbacher Abbruch Technik

Werkstatt • Lager • Service ^{seit 1977}

D-82229 Seefeld (bei München)

Graf-Toerring-Seefeld-Strasse 9b / 17

Tel. 08152 / 998 969-0 Fax.- 9

T.66 GRABENRÄUM-LÖFFEL (Holland-Profil) optimal* für Bagger von 23 bis 26 to

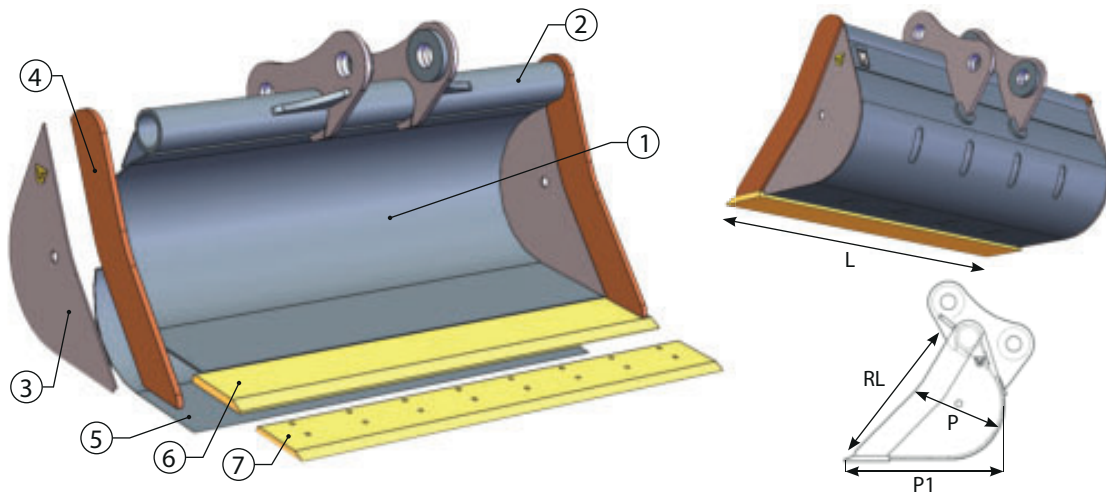
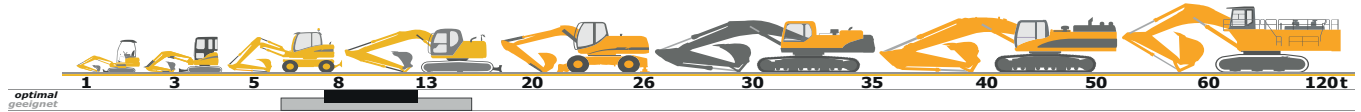

Classe Class	Codice Code	L mm.	Cap. SAE Lt.	Peso Kg. Weight	RL mm.	P mm.	P1 mm.	Listino € Price List	Sottolama € Bolt on blade
T.66 23 - 26 ton	WPE066-160	1600	930	590	1030	540	1006	3.556,00	448,00
	WPE066-180	1800	1066	650				3.846,00	506,00
	WPE066-200	2000	1200	700				4.134,00	562,00
	WPE066-220	2200	1334	750				4.416,00	618,00
	WPE066-240	2400	1470	800				4.696,00	674,00
	WPE066-250	2500	1535	830				4.856,00	704,00
		1	2	3	4	5	6	7 Optional	8
Materiale	Material	S355	S355	S355	Hardox 400	S355	HB 400	HB 400	/
Spessore	Thickness	8 mm	152.4 x 16 mm	8 mm	25 mm	8 mm	270 x 32 mm	250 x 25 mm	/



Schwiebacher Abbruch Technik

Werkstatt • Lager • Service seit 1977

D-82229 Seefeld (bei München)

Graf-Toerring-Seefeld-Strasse 9b / 17

Tel. 08152 / 998 969-0 Fax.- 9

T.66 GRABENRÄUM-LÖFFEL (Holland-Profil) optimal* für Bagger von 23 bis 26 to

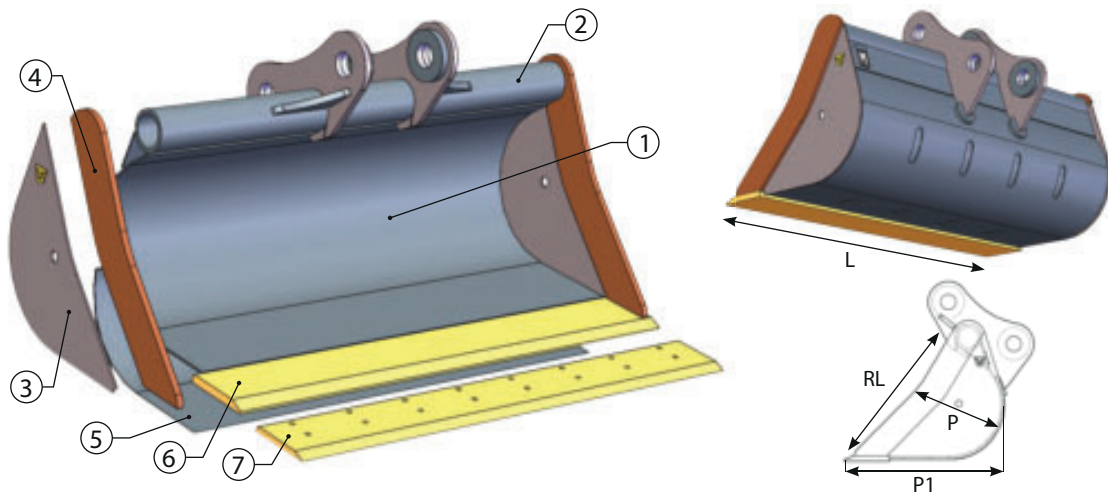

T66 *optimal = für Bagger von 23 bis 26 t mit Standard-Ausrüstung.

AKERMANN H10B * **ATLAS** 1802, 220 W, 225 LC, 240 LC * **BENATI** 3.22, 3.22B * **BENFRA** 10C/9.10/9.24
 * **CASE** 1088, 1188, CX 255 SR, CX 240B, WX 240, CX 245 DSR, CX 250D * **CATERPILLAR** 320 LINK C, M 325C, 225C, 225D, 324D, 325 FLCR * **JON DEERE** 250G, 245 GLC, 250 GLC * **DAEWOO DOOSAN** S 240, S 250, S 255LCV, DX 255, DX 255LC-5 * **FAI** 1600 * **FIATALLIS** FE 24 * **FIAT HITACHI** FH 220.3, FH 240.3, EX 255
 * **FIAT KOBELCO** EX 255EL/LC * **FORD** 48 * **FURUKAWA** 740LS, 640E * **HALLA** HE 220 LC
 * **HIDROMEK** HMK 220 LCLR * **HITACHI** ZX 245 USLC-6, ZX 250LC-6, ZX 250LCN-6 * **HYDROMAC** H 135, H 145 * **HYUNDAI** 228LC, R 250LC-3/7/9, HX 235L, HX 260L * **JCB** JS 240, JZ 255, JS 260 * **KOBELCO** SK 220, 235SR, 250LC, SK 210D-9, SK 210D-10, SK 260LC-10, SK 260 SRLC-3, SK 270 SRLC-5 * **KOMATSU** PC 220, PC 240-7/8, PC 240LC/NLC-10, PC 240LC/NLC-11
 * **LALTESI** 420, 500HD * **LIEBHERR** A 924B, R 912 LIT, R 914 LIT, R 914B LIT, R 916, A 924 HL LIT, R 924 LIT, A 924 HEAVY L LIT * **NEW HOLLAND** E 265, E 265 EL/LC * **O&K** RH 6PMS/RH 6.20/RH 6.22/RH 8PMS/MH 8.6/RH 6.5 * **PMI** 1000/1200/8.25/9.25
 * **POCLAIN** 90, 115 * **ROCK** 130, 135 * **SANY** SY 245H, SY 265C * **SAMSUNG** SE 240LC.3
 * **TEREX** TC 240LC, TC 240NLC, TC 260LC, TC 260NLC * **VOLVO** EC 240B/C, E 250D, ECR 235E, EC 250E *

geeignet = für Bagger von 21 bis 29 t je nach Ausrüstung.
 Andere **Klassen/Größen** bedingt geeignet. Bei Bedarf bitte anfragen!

Info: 05/2021



Schwiebacher Abbruch Technik

Werkstatt • Lager • Service seit 1977

D-82229 Seefeld (bei München)

Graf-Toerring-Seefeld-Strasse 9b / 17

Tel. 08152 / 998 969-0 Fax.- 9

T.68 GRABENRÄUM-LÖFFEL (Holland-Profil) optimal* für Bagger von 26 bis 31 to

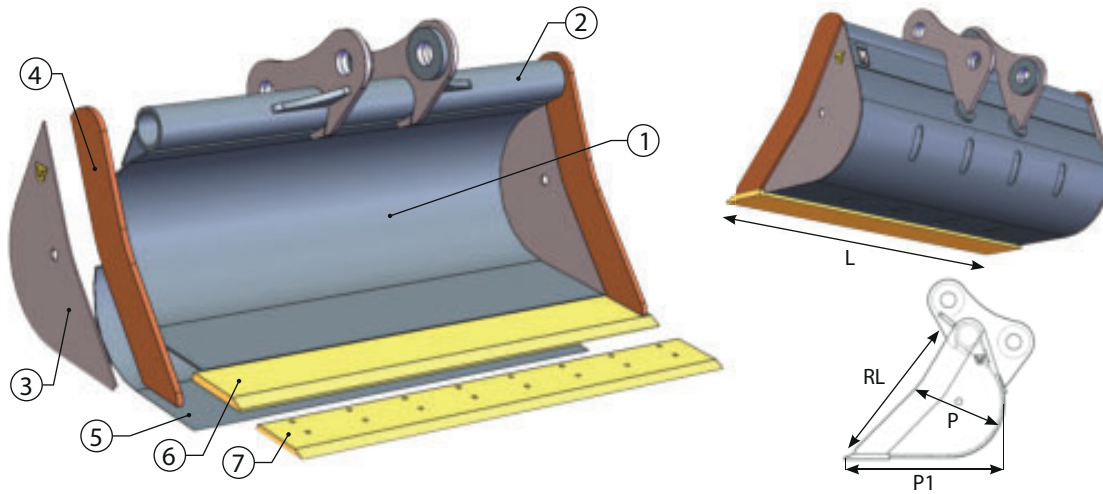

Classe Class	Codice Code	L mm.	Cap. SAE Lt.	Peso Kg. Weight	RL mm.	P mm.	P1 mm.	Listino € Price List	Sottolama € Bolt on blade
T.68 26 - 31 ton	WPE068-160	1600	1177	819	1155	625	1152	4.354,00	448,00
	WPE068-180	1800	1350	894				4.724,00	506,00
	WPE068-200	2000	1522	969				5.094,00	562,00
	WPE068-220	2200	1694	1044				5.458,00	618,00
	WPE068-240	2400	1867	1119				5.816,00	674,00
	WPE068-250	2500	1953	1156				5.974,00	704,00
		1	2	3	4	5	6	7 Optional	8
Materiale	Material	S355	S355	S355	Hardox 400	S355	HB 400	HB 400	/
Spessore	Thickness	10 mm	177.8 x 20 mm	10 mm	30 mm	10 mm	300 x 35 mm	250 x 25 mm	/



Schwiebacher Abbruch Technik

Werkstatt • Lager • Service ^{seit 1977}

D-82229 Seefeld (bei München)

Graf-Toerring-Seefeld-Strasse 9b / 17

Tel. 08152 / 998 969-0 Fax.- 9

T.68 GRABENRÄUM-LÖFFEL (Holland-Profil) optimal* für Bagger von 26 bis 31 to

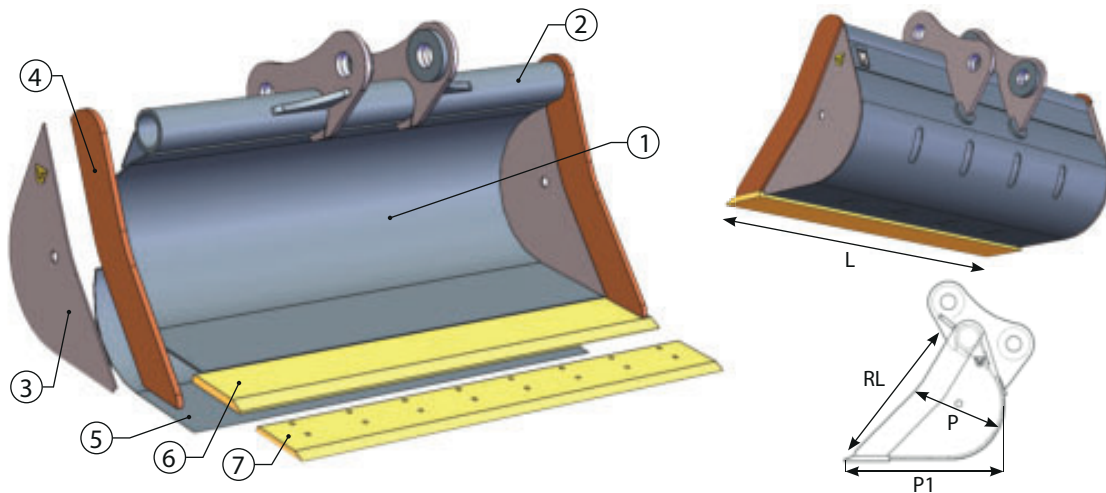

T.68 *optimal = für Bagger von 26 bis 31 t mit Standard-Ausrüstung.

AKERMANN H14B * **ATLAS** 2004, 340 LC * **BENATI** 230CSB, 270CSB, 370, 3.28, 3.30
 * **BENFRA** 12C/9.11/9.12 * **CASE** 1488, 9033, CX 330, CX 350, CX 350D, CX 370D
 * **CATERPILLAR** 330 LINK D/E, 330D, 330F, 336D, 335 FLCR * **COSMOTER** BAT 25C * **JON DEERE** 350G, 350 GLC * **DAEWOO DOOSAN** DH 320, S 330III/V, S 360LCIII, S 340LCV, DX 340, DX 340LC-5 * **FIATALLIS** FE 28 * **FIAT HITACHI** FH 300.2, FH 330.3, EX 355 * **FIAT KOBELCO** EX 55EL/LC/BEN * **FORD** 50 * **FURUKAWA** 645LS * **HIDROMEK** HMK 370, HMK 300 LCLR * **HITACHI** ZX 330LC-5G, ZX 350LC-6, ZX 350LCN-6, ZX 350LCH-5G * **HYDROMAC** H 150, H 180 * **HYUNDAI** H 230, H 270, R 320LC-3/7, R 360LC-3/7, R 380/9, HX 330L * **JCB** JZ 360, JS 330 * **KOBELCO** SK 330LC, 912, SK 330LC-10 * **KOMATSU** PC 340-7, PC 350-8, PC 360, PC 380, PC 360LC/NLC-10, PC 360LC/NLC-11, PC 365LC/NLC-3 **LALTESI** 541
 * **LIEBHERR** R 934B LIT, R 942 LIT, R 944B LIT, R 936 LIT, R924 CPT TUN LIT, R 934C LFR, R 934C DLN, R938 * **MF** 550 * **NEW HOLLAND** EE 335 LC/NLC, E 385, E 385 EL/LC/BEH
 * **O&K** RH 9E/F, G/PMS, RH 9.5, RH 8.5 * **PMI** 1300, 1500, 8.30, 8.34, 9.26, 9.30, 9.35
 * **POCLAIN** 125 * **ROCK** 125 * **SANY** SY 365H, SY 375H * **SAMSUNG** SE 280LC.2 * **VOLVO** EC 330B, EC 340, EC 360B/C, EC 380D *

geeignet = für Bagger von 23 bis 33 t je nach Ausrüstung.

Andere **Klassen/Größen** bedingt geeignet. Bei Bedarf bitte anfragen!



Schwienbacher Abbruch Technik

Werkstatt • Lager • Service seit 1977

D-82229 Seefeld (bei München)

Graf-Toerring-Seefeld-Strasse 9b / 17

Tel. 08152 / 998 969-0 Fax.- 9

T.69/T.70 GRABENRÄUM-LÖFFEL (Holland-Profil) optimal* für Bagger von 31 bis 43 to

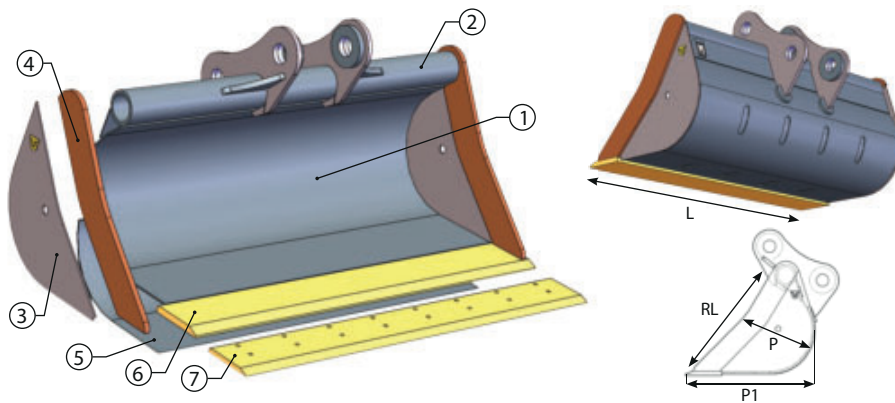

Classe Class	Codice Code	L mm.	Cap. SAE Lt.	Peso Kg. Weight	RL mm.	P mm.	P1 mm.	Listino € Price List	Sottolama € Bolt on blade
T.69 - T.70 31- 43 ton	WPE070-160	1600	1330	938	1240	660	1235	5.008,00	448,00
	WPE070-180	1800	1528	1016				5.396,00	506,00
	WPE070-200	2000	1725	1094				5.778,00	562,00
	WPE070-220	2200	1922	1172				6.152,00	618,00
	WPE070-240	2400	2118	1250				6.526,00	674,00
	WPE070-250	2500	2216	1290				6.696,00	704,00
		1	2	3	4	5	6	7 Optional	8
Materiale	Material	S355	S355	S355	Hardox 400	S355	HB 400	HB 400	/
Spessore	Thickness	10 mm	177.8 x 20 mm	10 mm	30 mm	10 mm	300 x 35 mm	250 x 25 mm	/

T.70 *optimal = für Bagger von 38 bis 43 t mit Standard-Ausrüstung.

AKERMANN H 16C * **ATLAS** 2004, 340 LC * **BENATI** 335/450/310CSB * **BENFRA** 9.32
 * **CATERPILLAR** 336 FLN, 336 FXE, 340F, 340F UHD * **JON DEERE** 380 GLC * **DAEWOO**
DOOSAN S 400LCIII/V, S 420LCV, DX 420, DX 380LC-5, DX 420LC-5 * **FIATALLIS** FE 28
 * **FIAT HITACHI** FH 400 * **FURUKAWA** 650E * **HALLA** HE 360LCH * **HIDROMEK** HMK 370LC
 HD, HMK 370 LCLR * **HITACHI** ZX 380LC-6, ZX 400, ZX 400LCH-3F, ZX 400LCH-5G
 * **HYDROMAC** H 200 * **HYUNDAI** R 420LC, HX 380L * **KOBELCO** SK 400 * **KOMATSU** PC
 400 * **LALTESI** 350 HD/551HD * **LIEBHERR** R 946, R944C SME, R 950 SME, R945 * **O&K** RH
 12.5/RH 14 * **PMI** 1485 * **POCLAIN** 170 * **ROCK** 200 * **SANY** SY 415H * **SAMSUNG** SE
 350LC.2 * **VOLVO** EC 380E *

geeignet = für Bagger von 35 bis 46 t je nach Ausrüstung.

Andere **Klassen/Größen** bedingt geeignet. Bei Bedarf bitte anfragen!

Info: 05/2021



SAT®

Schwienbacher Abbruch Technik

Werkstatt • Lager • Service seit 1977

D-82229 Seefeld (bei München)

Graf-Toerring-Seefeld-Strasse 9b / 17

Tel. 08152 / 998 969-0 Fax.- 9

T.69/T.70 GRABENRÄUM-LÖFFEL (Holland-Profil)
optimal für Bagger von 31 bis 43 to*

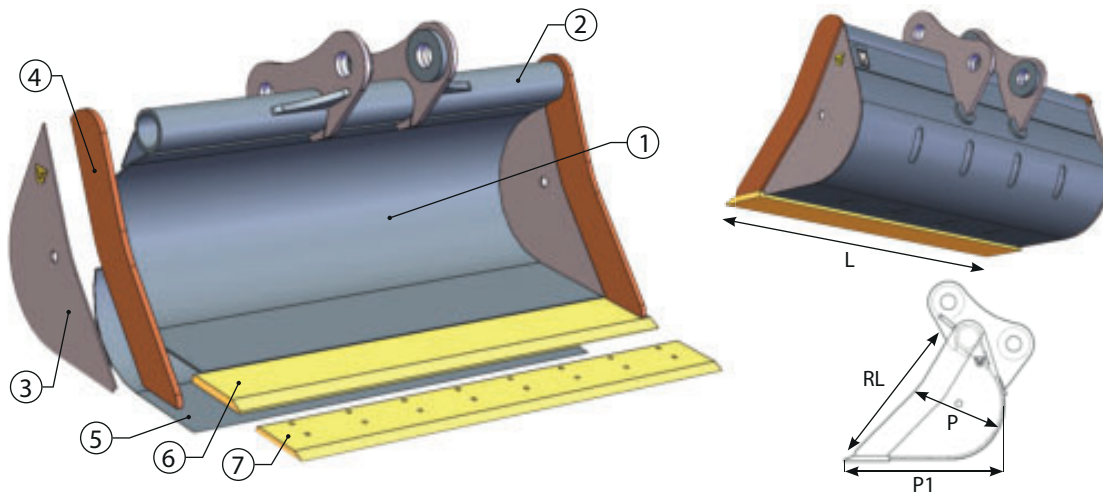

T. 69 *optimal = für Bagger von 31 bis 38 t mit Standard-Ausrüstung.

- AKERMANN** H14B * **ATLAS** 2004, 340 LC * **BENATI** 230CSB, 270CSB, 370, 3.28, 3.30
- * **BENFRA** 12C/9.11/9.12 * **CASE** 1488, 9033, CX 330, CX 350, CX 350D, CX 370D
- * **CATERPILLAR** 330 LINK D/E, 330D, 330F, 336D, 335 FLCR * **COSMOTER** BAT 25C * **JON**
- DEERE** 350G, 350 GLC * **DAEWOO DOOSAN** DH 320, S 330III/V, S 360LCIII, S 340LCV, DX
- 340, DX 340LC-5 * **FIATALLIS** FE 28 * **FIAT HITACHI** FH 300.2, FH 330.3, EX 355 * **FIAT**
- KOBELCO** EX 355EL/LC/BEN * **FORD** 50 * **FURUKAWA** 645LS * **HIDROMEK** HMK 370, HMK
- 300 LCLR * **HITACHI** ZX 330LC-5G, ZX 350LC-6, ZX 350LCN-6, ZX 350LCH-5G * **HYDROMAC** H
- 150, H 180 * **HYUNDAI** H 230, H 270, R 320LC-3/7, R 360LC-3/7, R 380/9, HX 330L * **JCB** JZ
- 360, JS 330 * **KOBELCO** SK 330LC, 912, SK 330LC-10 * **KOMATSU** PC 340-7, PC 350-8, PC
- 360, PC 380, PC 360LC/NLC-10, PC 360LC/NLC-11, PC 365LC/NLC-3 *
- LALTESI** 541 * **LIEBHERR** R 934B LIT, R 942 LIT, R 944B LIT, R 936 LIT, R924 CPT TUN LIT, R
- 934C LFR, R 934C DLN, R938 * **MF** 550 * **NEW HOLLAND** EE 335 LC/NLC, E 385, E 385
- EL/LC/BEH * **O&K** RH 9E/F, G/PMS, RH 9.5, RH 8.5 * **PMI** 1300, 1500, 8.30, 8.34, 9.26, 9.30,
- 9.35 * **POCLAIN** 125 * **ROCK** 125 * **SANY** SY 365H, SY 375H * **SAMSUNG** SE 280LC.2
- * **VOLVO** EC 330B, EC 340, EC 360B/C, EC 380D *

geeignet = für Bagger von 29 bis 41 t je nach Ausrüstung.
 Andere **Klassen/Größen** bedingt geeignet. Bei Bedarf bitte anfragen!

Info: 05/2021